

# INSTRUCTION MANUAL

## Static Remover Ionizer · Spot type ER-VS01

Thank you very much for using SUNX products. Please read this Instruction Manual carefully and thoroughly for the correct and optimum use of this product. Kindly keep this manual in a convenient place for quick reference.



- This product is to remove static electricity for industrial use. Never use this product for medical equipment etc. relating to maintenance/supervision of human life or body, for prevention of accidents which damage a human life or properties, or for safety maintenance.
- Since the tip of the discharge needle is pointed, take sufficient care in handling the discharge needle, or injuries may result.
- Do not use this product near or around surroundings containing any dangerous materials, such as combustible material and flammable material.
- The discharge needle gathers dust after a long period of use. In order to prevent accident or product malfunction, clean up the discharge needle, periodically once every two weeks or so, or this product will be unable to exert the charge removal performance.
- Be sure to ground the main body of this product via ground terminal to ensure electric shock prevention and reliable charge removal.
- Since the discharge needle is live with high voltage, never touch the discharge needle, or an electric shock may result.
- If this product is used in an airtight room, ozone emitted from this product may be detrimental. Therefore, in order for this product to be used in an airtight room, be sure to keep the room ventilated.
- Since the ion air contains ozone, do not aim this product at anyone.

### 1 OUTLINE

- This product is a compact, corona discharge type electrostatic charge removal device.
- This product neutralizes electrostatic charge from charged objects quickly and effectively.
- This product removes dust stuck to charged objects due to static electricity, and keeps such objects free from electrostatic dust.

### 2 CAUTIONS

- Make sure to use the DC power supply insulated by an isolation transformer etc. for this product. If an auto-transformer etc. (single winding transformer) is used, this product or the power supply may get damaged due to short-circuit.
- If the air supplied to this product is ON/OFF by a solenoid valve etc., turn the main power on/off simultaneously. [Discharge halt (DSC OFF) input should be used]
- If corona discharge is done without supplying air, the amount of ozone generation increases remarkably.
- Do not use during the initial transient time (0.5 sec.) after the power supply is switched on.
- If the power supply is switched on immediately after being switched off, fault output may be generated. After the power supply is switched off, keep an interval of 1 sec. or more, before switching it on again.
- Do not use this product beyond its rated specifications. Doing so can cause product breakdown, non-function, or damage. Further, it will also cause a marked reduction in product life.
- Never disassemble, repair, modify, or misuse this product, as it can cause accident or malfunction.
- Do not throw this product in fire. There is a danger of it exploding, or generating poisonous gas.
- Since this product emits ozone into the atmosphere, circulate the air if it is foul-smelling. If ozone stays for long period, metals etc. may oxidize/decay. Further, do not try to confirm the foul-smelling ozone by drawing your face near the nozzle outlet. There is a danger of hurting your nose, throat, etc.
- If this product is used immediately after storage in a high-humidity environment, its ion balance may remain lost. Therefore, before use, leave this product in the atmosphere with a temperature of +25°C or so and a relative humidity of 30% RH for over 8 hours.
- Do not use this product in steamy or dusty places and in places where water splashes or spatter flies when welding.
- Make sure that the power supply is off while wiring and inspection. Otherwise, there is a danger of accident, electric shock or malfunction.
- After wiring, reconfirm the wiring connections before switching on the power supply.
- Take care that wrong wiring will damage the product.
- Verify that the supply voltage variation is within the rating.
- If power is supplied from a commercial switching regulator, ensure that the frame ground (F.G.) terminal of the power supply is connected to an actual ground.
- In case a surge is generated in the used power supply, connect a surge absorber to the supply and absorb the surge.
- Do not run the wires together with high-voltage lines or power lines or put them in the same raceway. This can cause malfunction due to induction.
- Confirm the wiring and piping state before supplying power or air. Wrong wiring and piping may cause malfunction.
- Use air (dried clean air) for the fluid. Fluid other than air (dried clean air) or that containing corrosive gas may cause accident or malfunction.

- Do not use air containing foreign particles, such as, carbon dust or dust, water or oil. Since those may cause electric shock or malfunction, take appropriate measures, such as, installing an air-filter or an air-drier, etc.
- When maintenance, checkup or cleaning are carried out, make sure to cut the air supply completely and confirm that the inside the product and the tubes became atmospheric pressure in advance. The remained air pressure may cause accident or malfunction.
- Do not use this product for a purpose other than charge removal.
- This product is CE-conformed under the EMC Directive. The immunity adopted by this product should be conformable to EN 61000-6-2. In order for such immunity to be conformable to this standard, all wires connected to this product should be limited in length to less than 10m.
- When this product is no longer usable or required, carry out the appropriate disposal process meant for industrial waste.

### 3 SPECIFICATIONS

Type	Spot type	
Item Model No.	<b>ER-VS01</b>	
Charge removal time	1 sec. or less (Note 1)	
Ion balance	± 15V or less (Note 1)	
Ozone generation	0.03ppm or less (Note 2)	
Applicable fluid	Air (dried clean air) (Note 3)	
Supplied air flow	500 ℓ/min (ANR) or less (Note 4)	
Air pressure range	0.05 to 0.7MPa (Note 4)	
Supply voltage	24V DC ± 10%	
Current consumption	70mA or less	
Discharge method	High frequency AC method	
Discharge output voltage	2,000V approx.	
Check output (CHECK)	NPN open-collector transistor <ul style="list-style-type: none"> <li>• Maximum sink current : 50mA</li> <li>• Applied voltage : 30V DC or less (between check output and 0V)</li> <li>• Residual voltage : 1V or less (at 50mA sink current)</li> </ul>	
Output operation	ON when a dirt or wear etc. of the discharge needle is detected, OFF when operation is normal (Note 5)	
Short-circuit protection	Incorporated	
Error output (ERROR)	NPN open-collector transistor <ul style="list-style-type: none"> <li>• Maximum sink current : 50mA</li> <li>• Applied voltage : 30V DC or less (between error output and 0V)</li> <li>• Residual voltage : 1V or less (at 50mA sink current)</li> </ul>	
Output operation	OFF when abnormal discharge is detected, ON when operation is normal (Note 5)	
Short-circuit protection	Incorporated	
Discharge halt input (DSC OFF) (Note 6)	Discharge halt: short-circuit with 0V Discharge allowed (operation start): Open	
Reset input (RESET)	In the state that operation is stopped due to an error detection, open 0V of the power supply from short-circuit state to cancel ERROR.	
Indicator	Power	Green LED (lights up when the power is ON)
	Discharge	Green LED (lights up when discharging)
	Check	Orange LED (lights up when a dirt or wear etc. of the discharge needle is detected)
	Error	Red LED (lights up when error is detected)
Ambient temp./humidity	0 to +55°C/35 to 65% RH (No dew condensation)	
Cable	Cable with a connector, 0.5m long	
Material	Enclosure: PPS, Cover: Stainless steel, Discharge needle: Tungsten	
Weight	120g approx.	
Accessory	Connector for wiring: 1 set [Manufactured by Molex: Housing (5557-08R), Terminal (5556T)]	

Notes: 1) A typical sample (measured on a sample left in the atmosphere at a relative humidity of 65% RH for 24 hours) applied with a power voltage of 24V, a distance of 100mm from the front surface of the airflow inlet and a pressure of 0.25MPa while the shower nozzle is in use.  
2) A typical sample applied with a power voltage of 24V, a distance of 300mm from the front surface of the air flow inlet and a pressure of 0.25MPa while the shower nozzle is in use.  
3) The air is dried (dew point: equivalent of -20°C) and filtered (mesh-size: equivalent of 0.01 μm) air.  
4) The applicable pressure range depends on the nozzle to be used.  
5) When the power is ON, or the discharge halt input is activated, the check output may operate transitively, however, the charge removal capability remains the same. In case of using the check output to halt the device or give an alarm etc., use a sequence controller that processes with 5 sec., or more, output.  
6) "DSC" stands for "DISCHARGE".

#### ● Options

##### • Nozzle and Holder

For details of the nozzle and holder, refer to the instruction manual enclosed with the nozzle.

##### • AC adapter

Model No.	Description
ER-VAPS	IN: 100 to 120V AC, 50/60Hz, 40VA OUT: 24V DC, 750mA

##### • Discharge unit

Model No.	Description
ER-VANT	Unit with Tungsten needle (1 set)

### 4 MOUNTING

- When this product is mounted on a housing, use M4 screws. (please arrange separately.) The tightening torque should be 2N·m or less.
- If more than 2 units are mounted closely, keep 5mm, or more, distance between them. Otherwise, the capability may be affected.
- Make sure to ground this product. If the grounding is not proper, the charge removal capability is reduced. (Direct earth or power supply common earth)
- If AC adapter is used, be sure to connect the ground terminal to the power supply common earth.

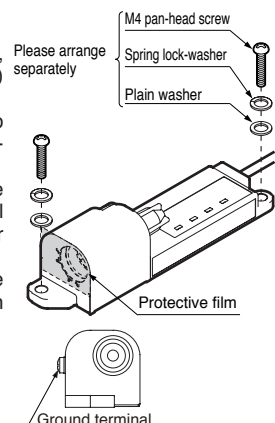



- This product cannot be used by its own. Be sure to fit the optional nozzle for use of this product.
- For the details of the optional nozzle, refer to the instruction manual enclosed with the nozzle.

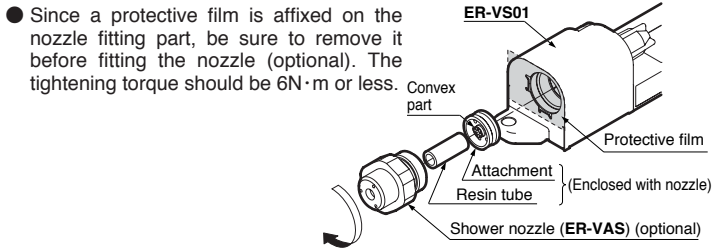

## 5 PIPING

- The outer diameter of the air-tube to fit to the air inlet portion of this product should be  $\phi 6\text{mm}$ .
- Make sure that clean air (air containing no-water, no-oil and no dust) should be supplied.
- Since the pressure will drop when the air piping from the main pressure supply is extended or pneumatic-components (e.g., needle valve, spin core, mini filter) are added, keep an eye on the pressure supply to the ionizer making sure it isn't in short supply. For the pneumatic-components, select those that can accommodate the air supply flow rate.

## 6 I/O CIRCUIT DIAGRAMS

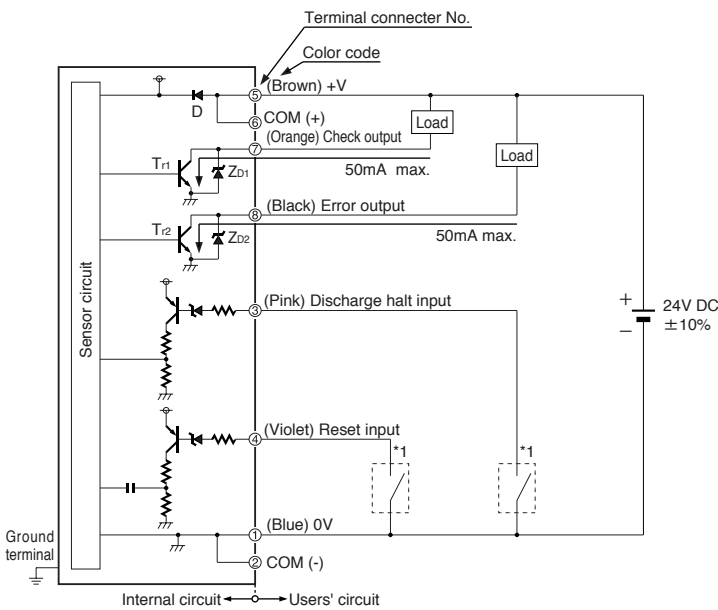

Symbols... D: Reverse supply polarity protection diode  
 ZD1, ZD2: Surge absorption zener diode  
 Tr1, Tr2: NPN output transistor

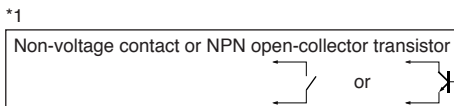

- Discharge halt input  
 Low (0V): Discharge halt  
 High (Open): Discharge allowed (Operation starts)
- Reset input  
 In the state that operation is stopped due to an error detection, open 0V of the power supply from short-circuit state to cancel ERROR

### ● Connector pin arrangement

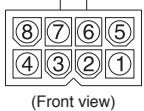

Terminal No.	Terminal	Color code
①	0 V	Blue
②	COM (-)	—
③	Discharge halt input	Pink
④	Reset input	Violet
⑤	24V	Brown
⑥	COM (+)	—
⑦	Check output	Orange
⑧	Error output	Black

## 7 INPUT SIGNAL CONDITIONS

- Conditions for the discharge halt input and the reset input are as follows.

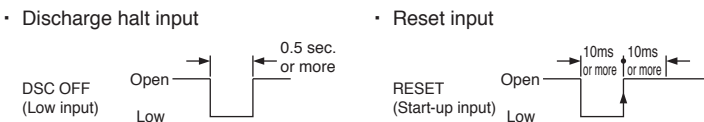

Note: Repeat control with 'DSC OFF' input should be 1Hz or less.

## 8 OPERATION MATRIX

	Indicators (☀: Lights up, ○: OFF)				Output		Discharge through needle
	Power	Discharge	Check	Error	Check	Error	
	Green	Green	Orange	Red	N.O.	N.C.	
Normal	☀	☀	○	○	OFF	ON	ON
Check	☀	☀	☀	○	ON	ON	ON
Error	☀	○	○	☀	OFF	OFF	OFF
Discharge halt input	☀	○	○	○	OFF	ON	OFF
Reset input	☀	(Maintained)	(Maintained)	○	(Maintained)	ON	(Allowed)

- Notes: 1) 'DSC OFF' input in the 'ERROR' state is invalid (since the 'ERROR' state is prioritized).  
 2) 'RESET' input is enabled even when in the 'DSC OFF' input state, and 'DSC OFF' input remains unaffected by 'RESET' input.  
 3) 'RESET' input in the 'ERROR' state resumes the 'ERROR' state unless the cause of the error has been eliminated.

## 9 MAINTENANCE



- Before checking the high-voltage part, be sure to turn off the power supply, or you may get an electric shock.
- Since the tip of the discharge needle is pointed, take sufficient care when cleaning. There is a danger of injury.

- Since the removal discharge effect will deteriorate if dirt is stuck to the tip of the discharge needle, clean the discharge needle periodically.
- The maintenance required depends on the environment of use. As a reference, the maintenance should be done once in two weeks.
- The discharge needle is a part having a product life time. It is recommended that the needle should be replaced, as a reference, after 10,000 hours in use. When replacing it, replace the whole unit.

### Procedure of cleaning and replacing the discharge needle

- ① Confirm that the power supply is off.
- ② Unscrew the discharge needle counter-clockwise.
- ③ Remove the dirt on and around the discharge needle with a cotton bud soaked in alcohol.
- ④ After cleaning, screw the needle clockwise to fit. The tightening torque should be 0.3N·m or less.

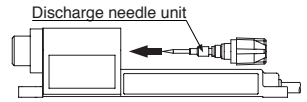

## 10 TROUBLE SHOOTING



Make sure that the power supply is off while checking the high-voltage part. Otherwise, you may get an electric shock.

Symptom	Remedy
Check indicator (orange) lights up	<ul style="list-style-type: none"> <li>• Make sure that the power voltage is within the tolerance as per specifications.</li> <li>• Check the tip of the discharge needle for chip and contamination, and make sure that the discharge needle unit is mounted normally on the main body.</li> <li>• If the CHECK indicator (orange) lights up even after cleaning the discharge needle, also check the nozzle part for contamination.</li> <li>• Make sure that the nozzle assembly (including the attachment and the resin tube) is mounted properly.</li> <li>• Make sure that the air pressure is within the applicable range as per specifications.</li> </ul>
Error indicator (red) lights up	<ul style="list-style-type: none"> <li>• Make sure that the power voltage is within the tolerance as per specifications.</li> <li>• Abnormal discharge is possible.</li> <li>• Turn off the power supply, check the tip of the discharge needle for chip and contamination, and make sure that the discharge needle unit is mounted normally on the main body. Also, check the inside of the nozzle for foreign objects, and make sure that the nozzle is mounted and installed properly.</li> <li>• Make sure that the ground terminal is connected completely.</li> </ul>
Doesn't go back to normal state by reset	<ul style="list-style-type: none"> <li>• Make sure that the cause of the error has been eliminated.</li> </ul>

## 11 DIMENSIONS (Unit: mm)

- Mounting drawing with shower nozzle (optional)

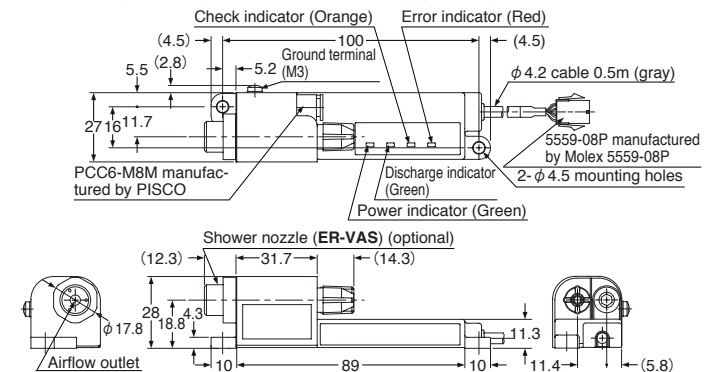

## SUNX Limited

<http://www.sunx.co.jp/>

Head Office  
 2431-1 Ushiyama-cho, Kasugai-shi, Aichi, 486-0901, Japan  
 Phone: +81-(0)568-33-7211 FAX: +81-(0)568-33-2631

Overseas Sales Dept.  
 Phone: +81-(0)568-33-7861 FAX: +81-(0)568-33-8591